

1 卷



運河畑 造成



多造り水門
(海水 出口)

満潮
で閉

満潮
で閉

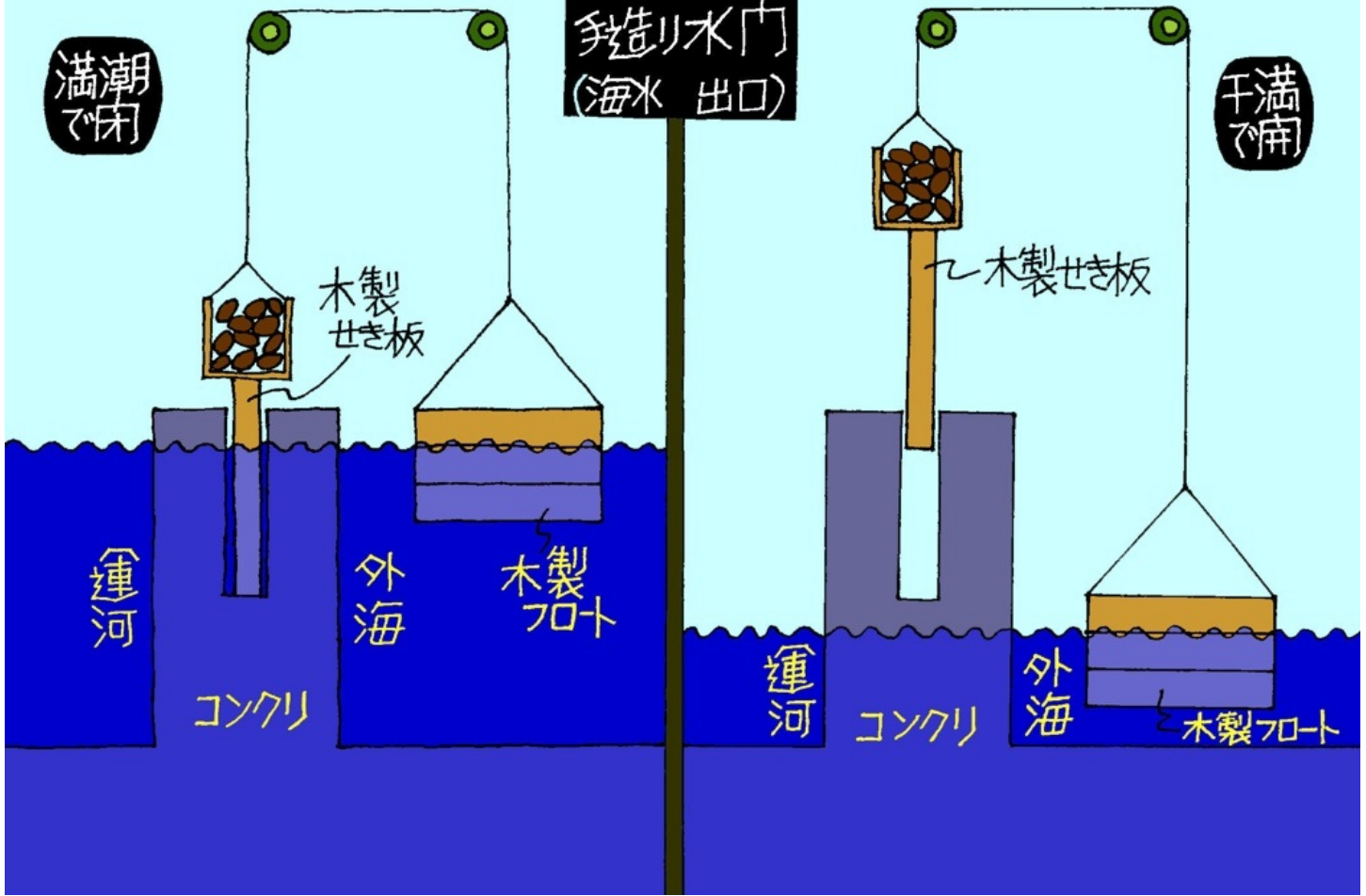

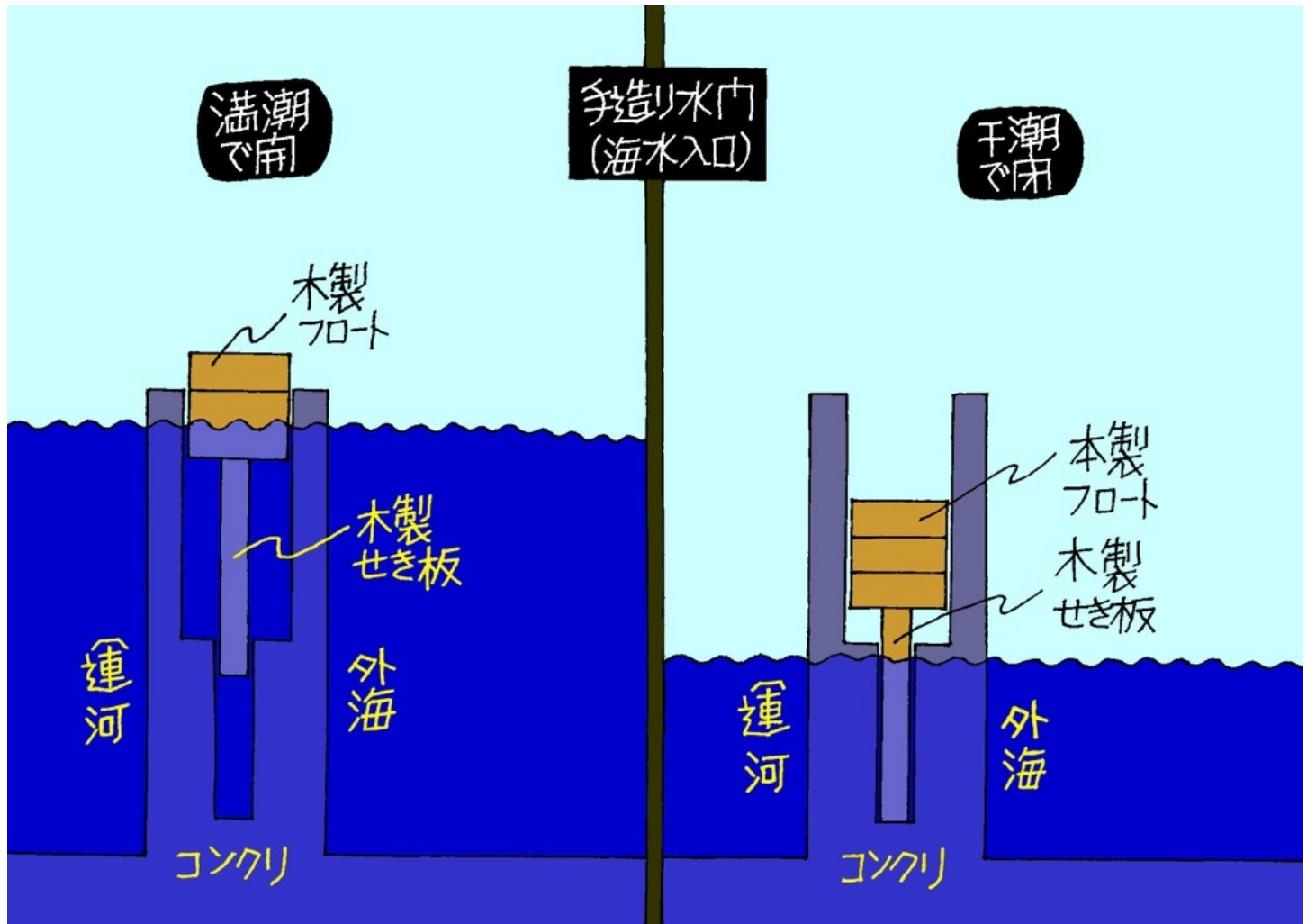

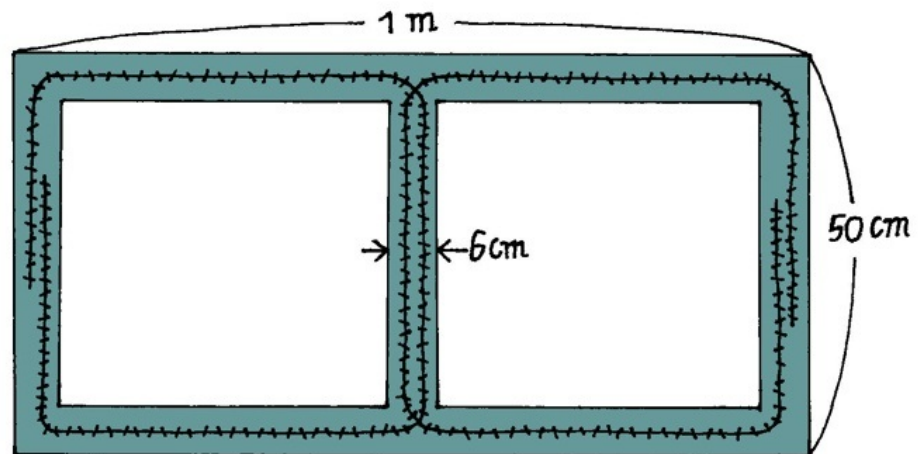
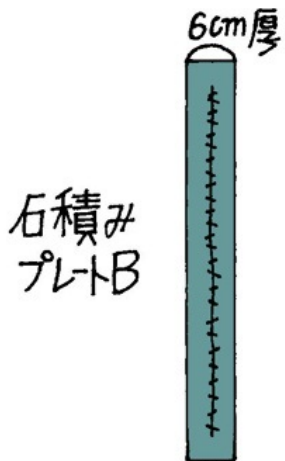
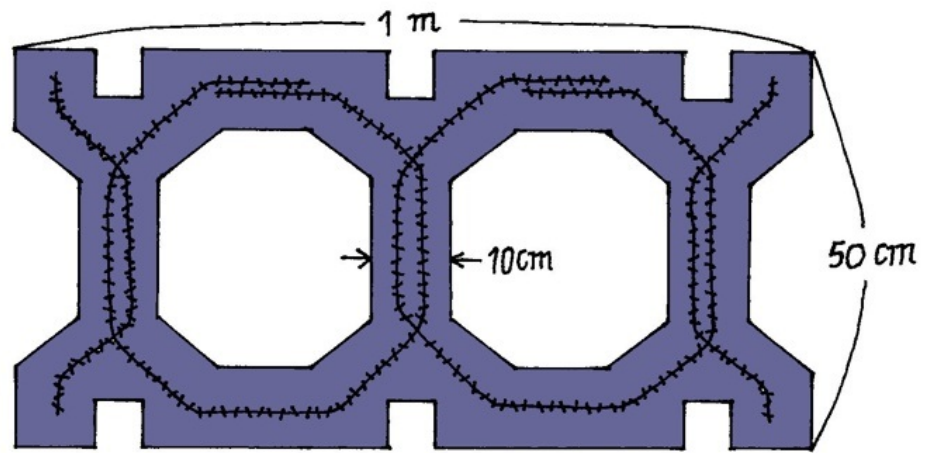
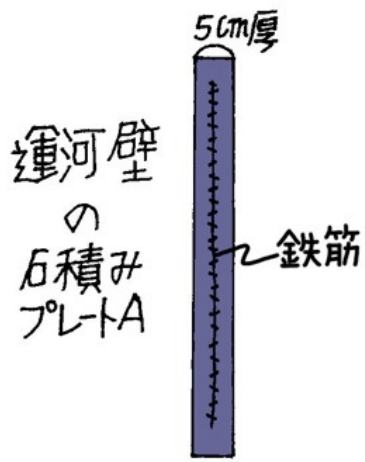

運河壁の組立
石積みプレート
A×B

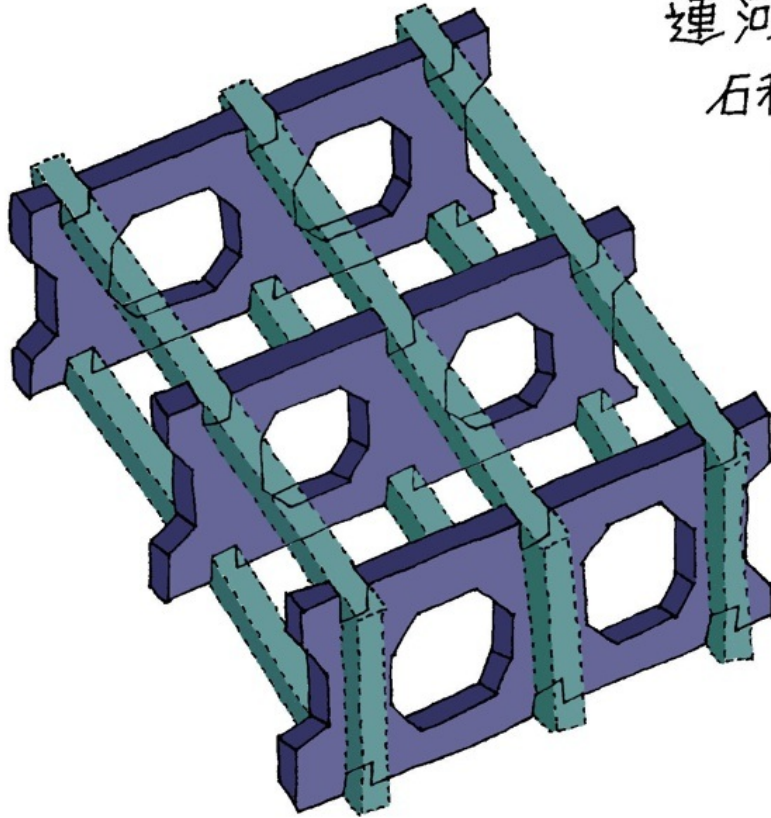

運河壁の組立
石積みプレート
A×B

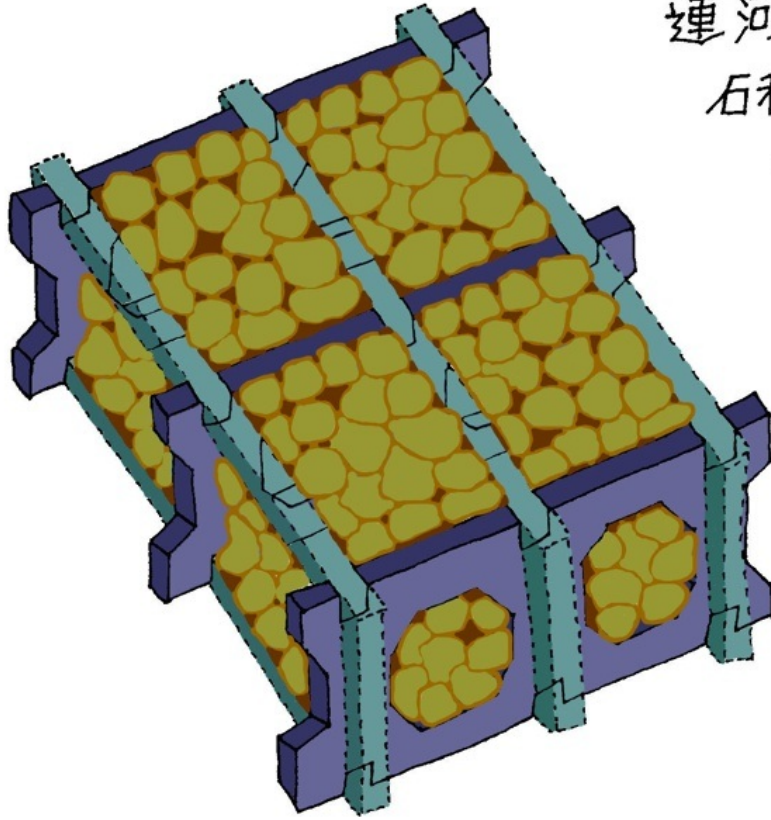

海藻ロープ用滑車(竹製)

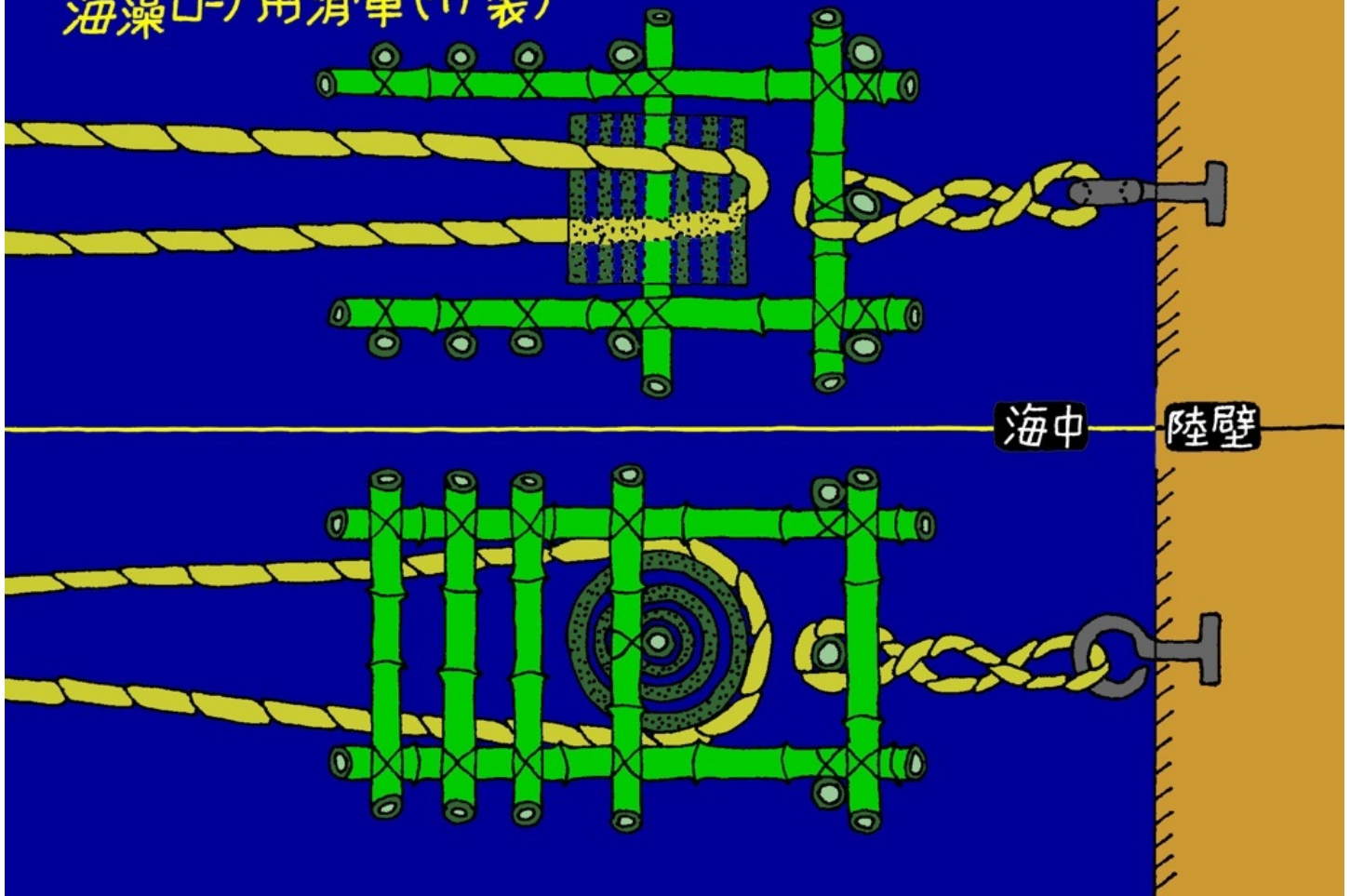

運河火田壁6段積み

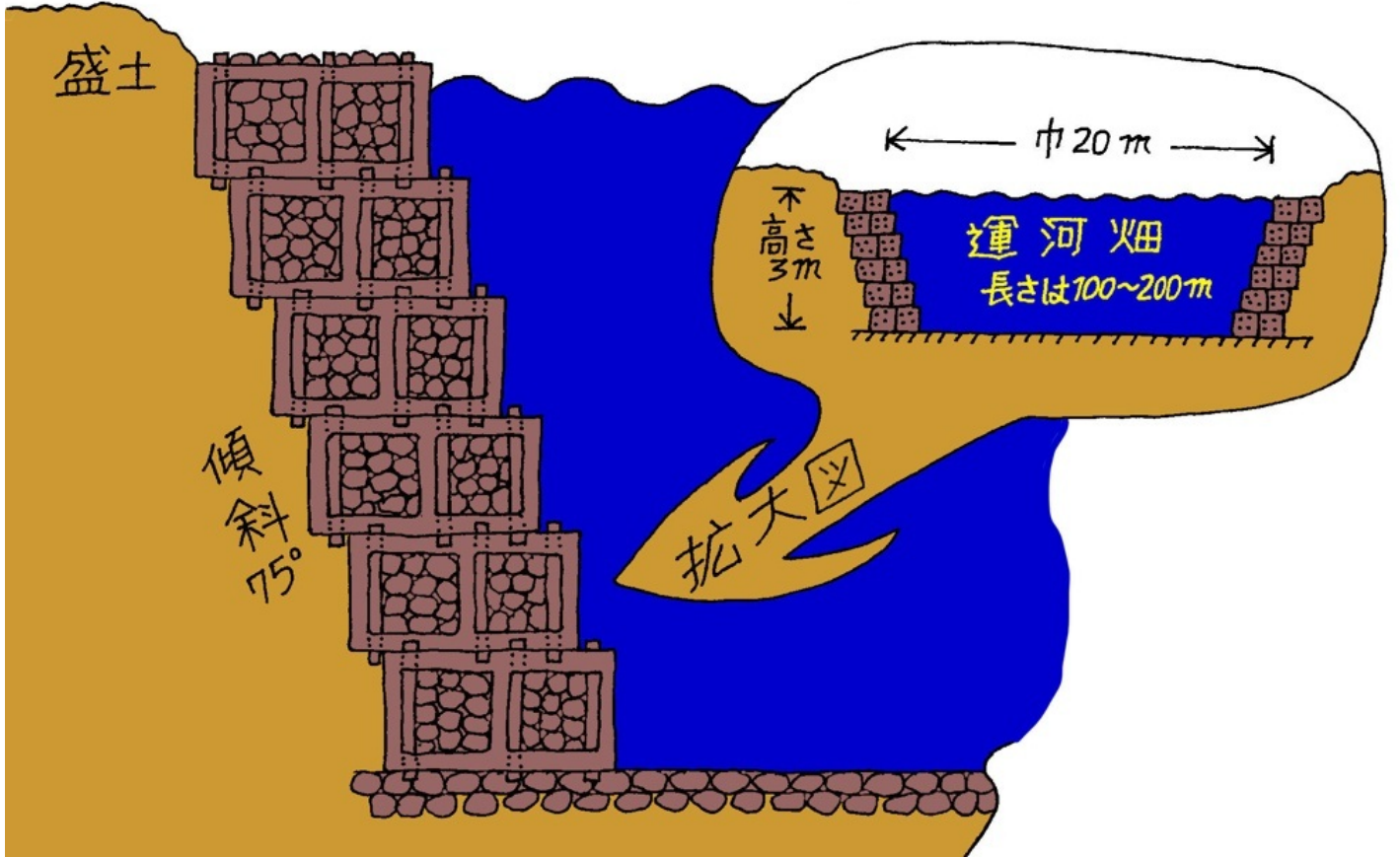

海藻ロープを張った運河畑

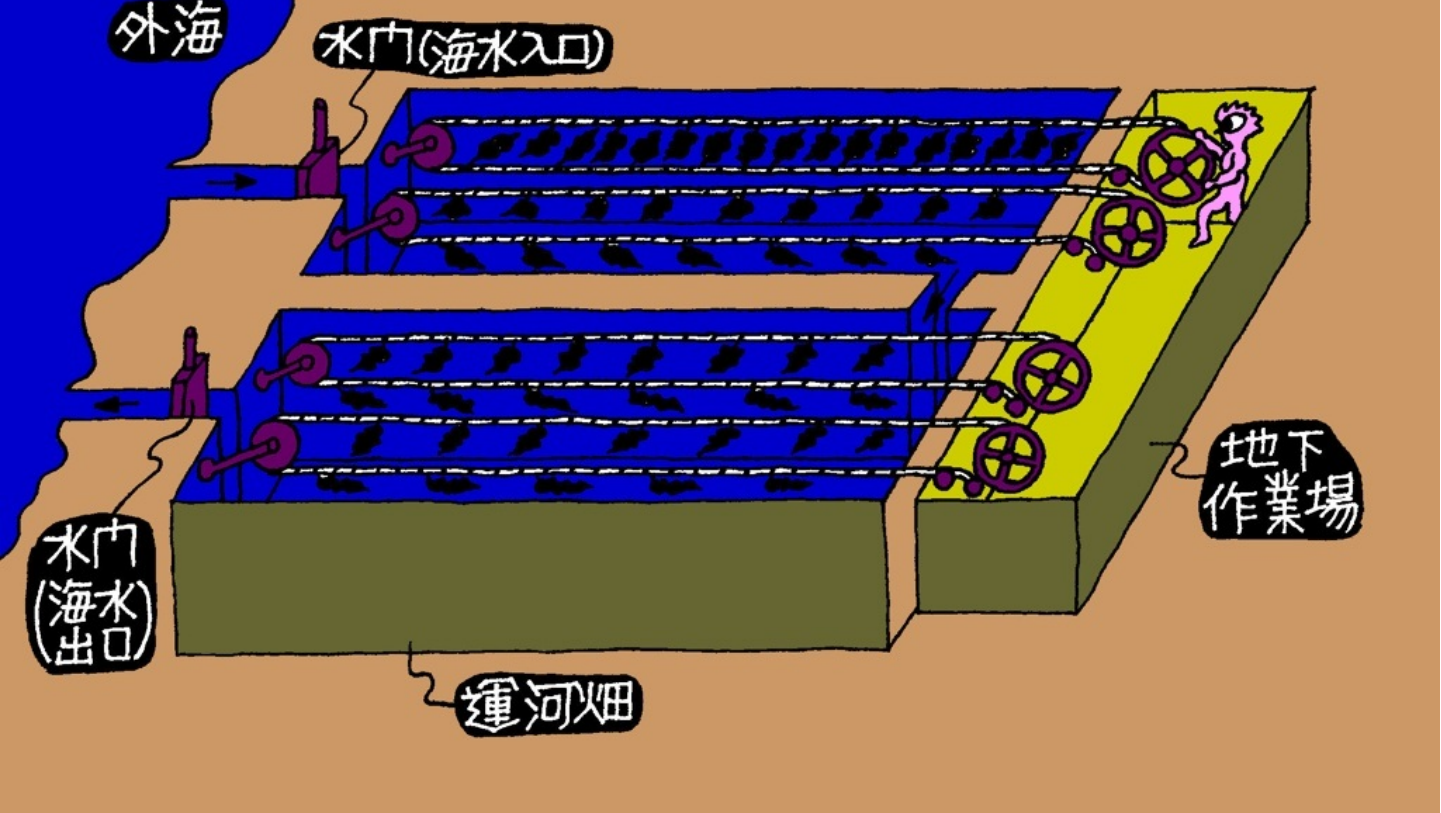

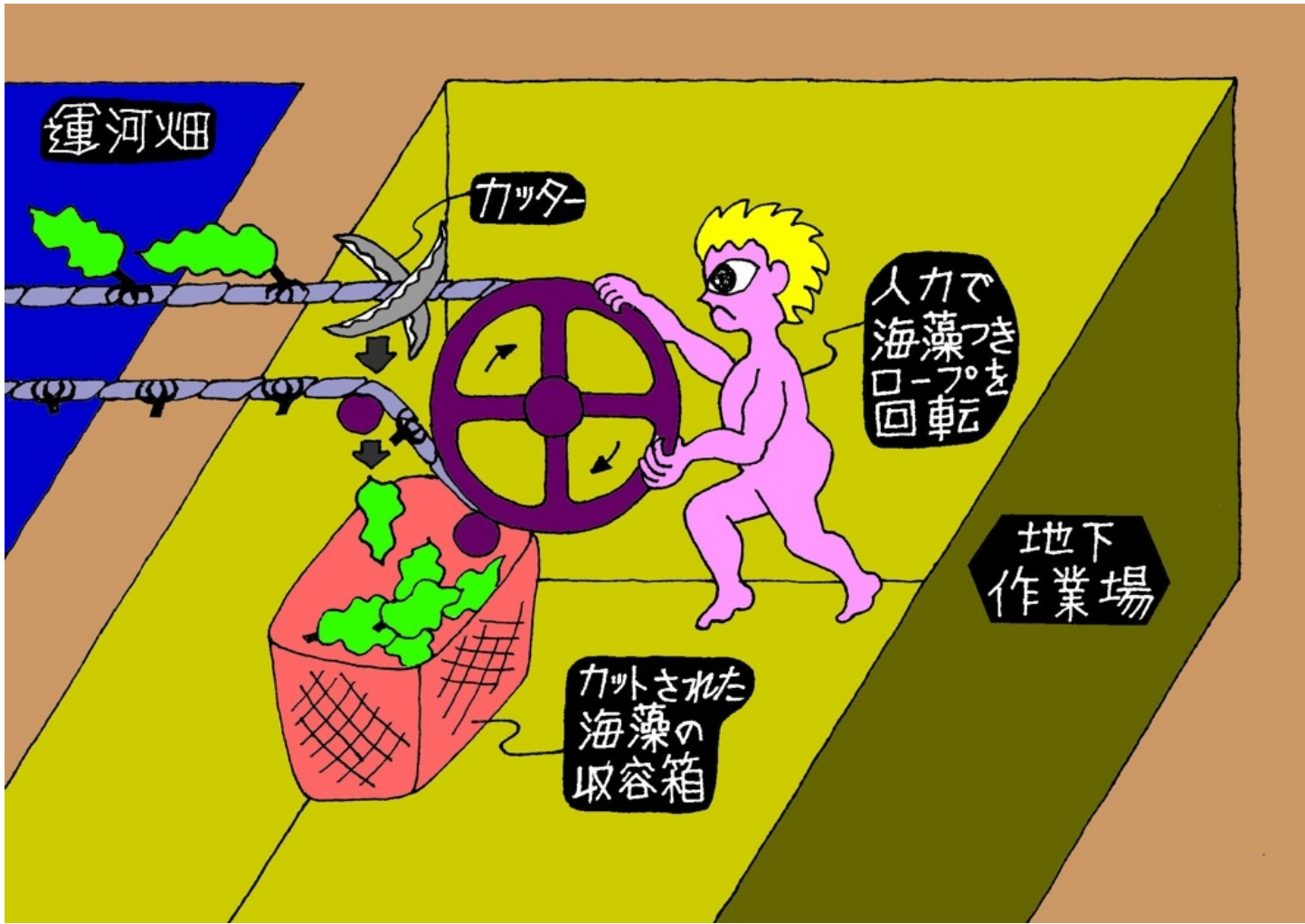

海藻つきロープから海藻の切り離し

